



Technical Data Sheet

Opto Interrupter

ITR8307/S17

■ Features

- Fast response time
- High sensitivity
- Cut-Off visible wavelength
- Thin
- Compact
-

■ Descriptions

ITR8307/S17 is a light reflection switch which includes a GaAs IR-LED transmitter and a NPN photo-transistor with a high photosensitive receiver for short distance, operating in the infrared range. Both components are mounted side- by- side in a plastic package.

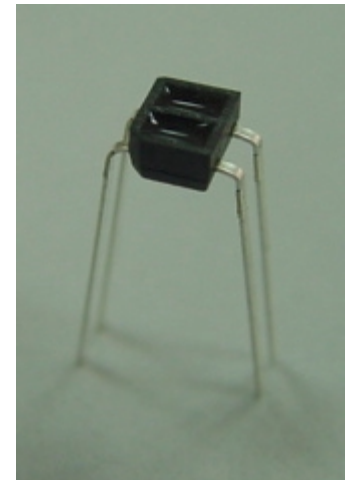

■ Applications

- Camera
- VCR
- Floppy disk driver
- Cassette type recorder
- Various microcomputer control equipment

■ Device Selection Guide

Device No.	Chip Material
IR	GaAs
PT	Silicon

Device No:DRX-083-103

Package Dimensions

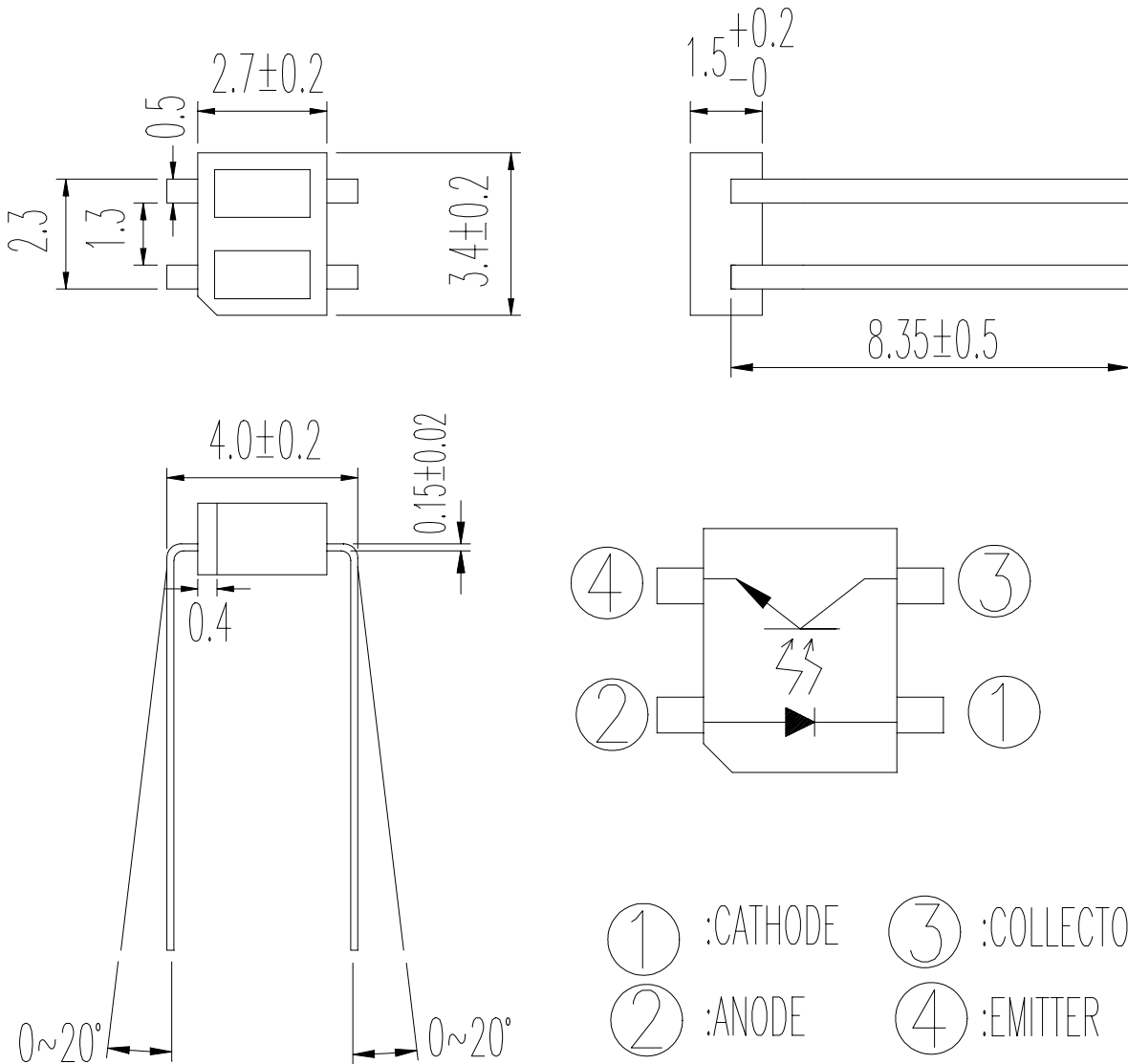

- Notes:**
- 1.All dimensions are in millimeters
 - 2.Tolerances unless dimensions ± 0.15 mm

Absolute Maximum Ratings (Ta=25°C)

Parameter		Symbol	Ratings	Unit
Input	Power Dissipation at(or below) 25°C Free Air Temperature	Pd	75	mW
	Reverse Voltage	V _R	5	V
	Forward Current	I _F	50	mA
	Peak Forward Current (*1) Pulse width ≤ 100 μs, Duty cycle=1%	I _{FP}	1	A
Output	Collector Power Dissipation	P _C	75	mW
	Collector Current	I _C	50	mA
	Collector-Emitter Voltage	B V _{CEO}	30	V
	Emitter-Collector Voltage	B V _{ECO}	5	V
Operating Temperature		Topr	-20~+70	°C
Storage Temperature		Tstg	-30~+80	°C
Lead Soldering Temperature (*2) (1/16 inch form body for 5 seconds)		Tsol	260	°C

(* 1) $t_w=100 \mu \text{ sec.}$, $T=10 \text{ msec.}$ (* 2) $t=5 \text{ Sec}$

Electro-Optical Characteristics (Ta=25°C)

Parameter		Symbol	Min.	Typ.	Max.	Unit	Conditions	
Input	Forward Voltage	V _F	---	1.2	1.6	V	I _F =20mA	
	Reverse Current	I _R	---	---	10	μA	V _R =5V	
	Peak Wavelength	λ _p	---	940	---	nm	---	
	View Angle	2θ _{1/2}	---	110	---	Deg	I _F =20mA	
Output	Dark Current	I _{CEO}	---	---	100	nA	V _{CE} =10V	
	C-E Saturation Voltage	V _{CE(sat)}	---	---	0.4	V	I _C =2mA ,Ee=1mW/cm ²	
Transfer Characteristics	Light Current	I _{C(ON)}	B	180	---	300	μA	V _{CE} =5V I _F =10mA
			C	250	---	440		
	Leakage Current	I _{CEOD}	---	---	1	μA		
	Rise time	t _r	---	20	---	μsec	V _{CE} =2V	
Fall time	t _f	---	20	---	μsec	I _C =100 μA R _L =1KΩ		

Device No:DRX-083-103

Typical Electrical/Optical/Characteristics Curves for IR

Fig. 1 Forward Current vs. Ambient Temperature

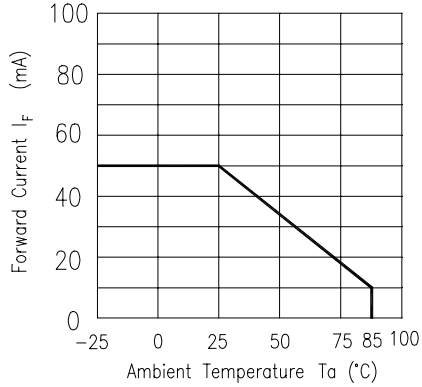

Fig. 2 Spectral Distribution

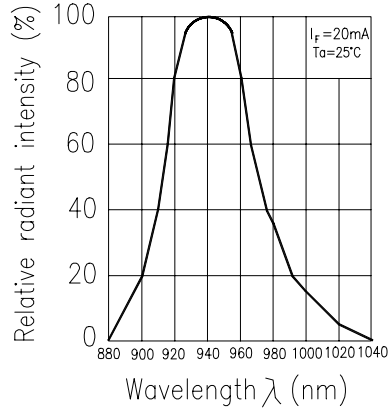

Fig. 3 Peak Emission Wavelength vs. Ambient Temperature

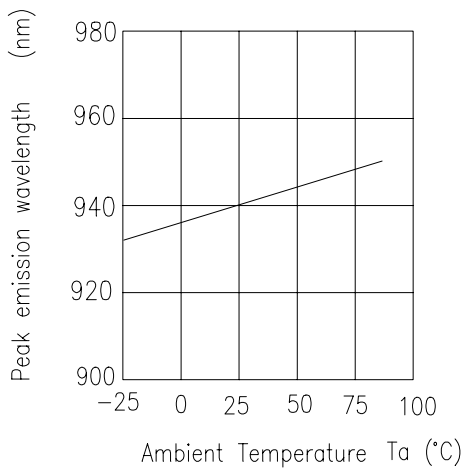

Fig. 4 Forward Current vs. Forward Voltage

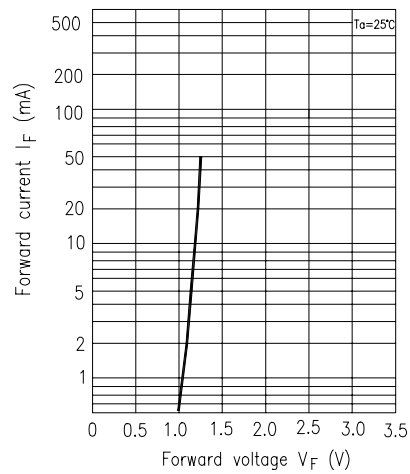

Fig. 5 Forward Voltage vs. Ambient Temperature

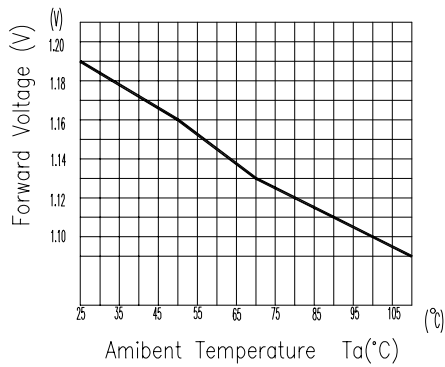
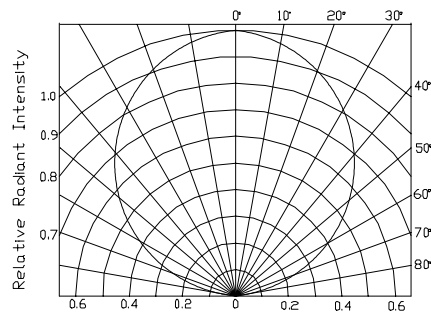

Fig. 6 Relative Radiant Intensity vs. Angular Displacement



Device No:DRX-083-103

Typical Electrical/Optical/Characteristics Curves for PT

Fig.1 Collector Power Dissipation vs. Ambient Temperature

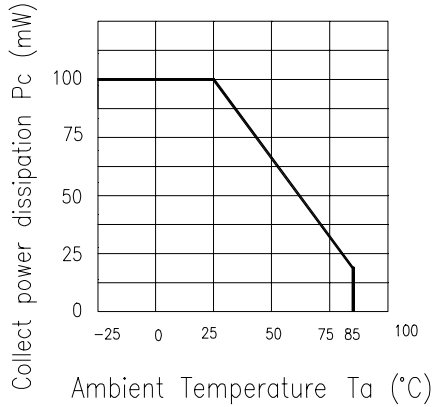

Fig.2 Collector Dark Current vs. Ambient Temperature

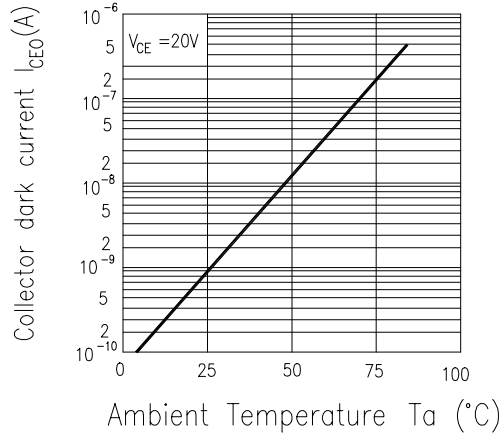

Fig. 3 Relative Collector Current vs. Ambient Temperature

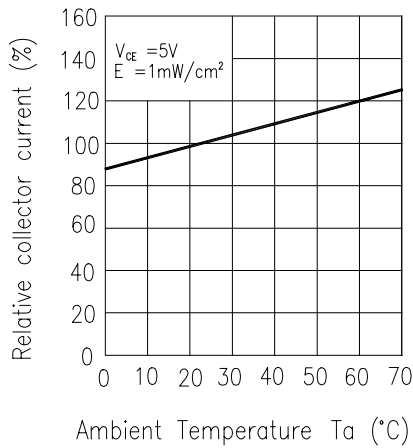

Fig.4 Collector Current vs. Irradiance

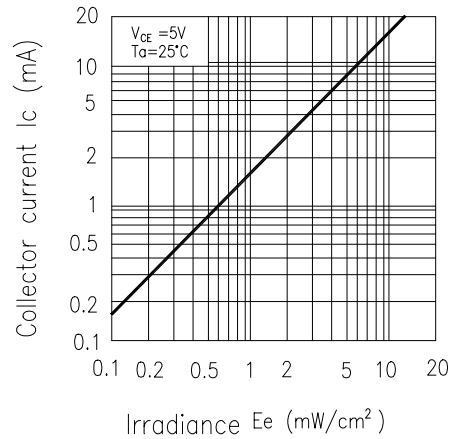

Fig.5 Spectral Sensitivity

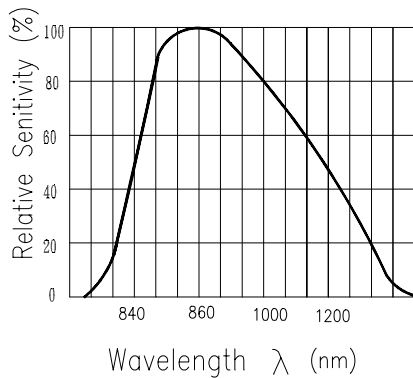
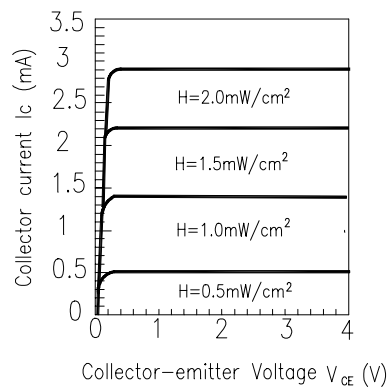

Fig.6 Collector Current vs. Collector-emitter Voltage



Typical Electrical/Optical/Characteristics Curves For ITR

Fig.7 Relative Collector Current vs. Distance between Sensor and Al Evaporation Galss

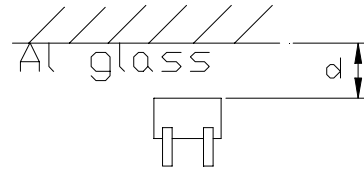
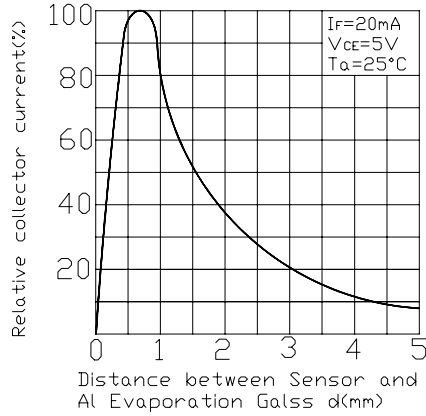

Fig.8 Relative Collector Current vs. Card Moving Distance (l)

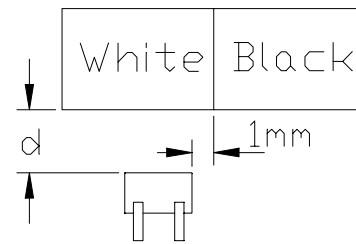
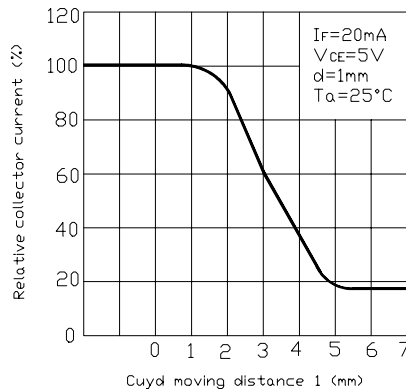
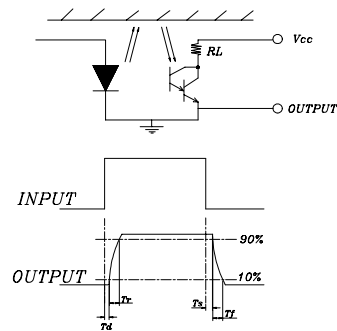
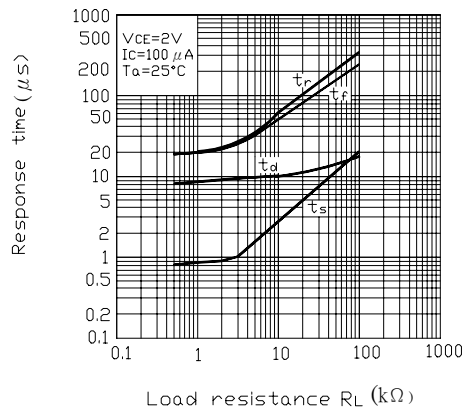

Fig.9 Response Time vs. Load Resistance (GP2S24/GP2S26/GP2S27)



Device No:DRX-083-103

Reliability Test Item And Condition

The reliability of products shall be satisfied with items listed below.

Confidence level : 90%

LTPD : 10%

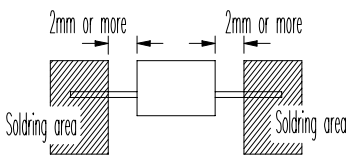
NO.	Item	Test Condition	Test Hours/ Cycle	Sample Size	Failure Judgement Criteria	Ac/Re
1	Solderability 	TEMP : 230°C ± 5 °C	5 sec	22 PCs	More than 90% of lead to be covered by soldering	0/1
2	Temperature Cycle	H : +85°C 30 mins ↓ 5 min ↑ L : -55°C 30 min	50 cycle	22 PCs	$I_R \geq U \times 2$ $E_e \leq L \times 0.8$ $V_F \geq U \times 1.2$	0/1
3	Thermal Shock	H : +100°C 5 min ↓ 10 sec ↑ L : -10°C 5 min	50 cycle	22 PCs	U :Upper specification limit L :Lower specification limit	0/1
4	High Temperature Storage	TEMP. : +100°C	1000 hrs	22 PCs		0/1
5	Low Temperature Storage	TEMP. : -55°C	1000 hrs	22 PCs		0/1
6	DC Operating Life	$V_{CE}=5V$ $I_F=20mA$	1000 hrs	22 PCs		0/1
7	High Temperature / High Humidity	85°C / 85% R.H.	1000 hrs	22 PCs		0/1

EVERLIGHT ELECTRONICS CO., LTD.
 Office: No 25, Lane 76, Sec 3, Chung Yang Rd,
 Tucheng, Taipei 236, Taiwan, R.O.C

Tel: 886-2-2267-2000, 2267-9936
 Fax: 886-2267-6244, 2267-6189, 2267-6306
<http://www.everlight.com>

Device No:DRX-083-103